

version .0

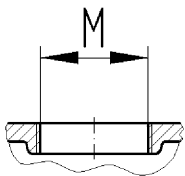

version .1

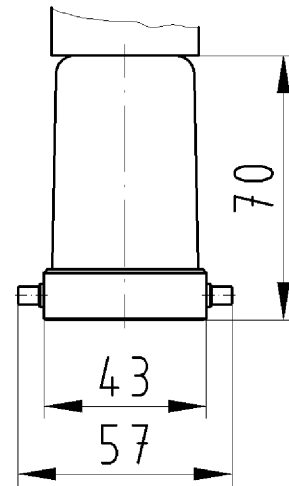
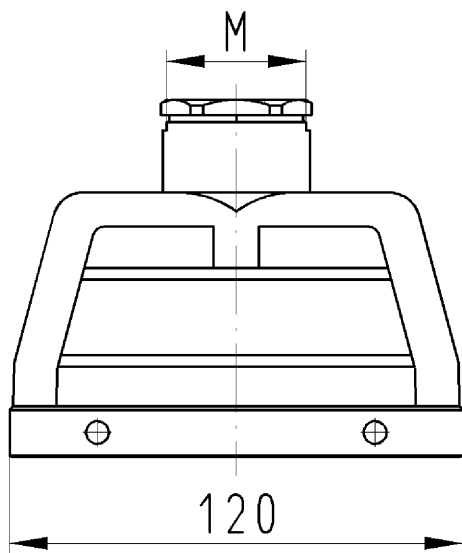
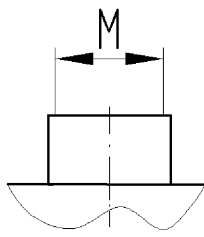

version .2

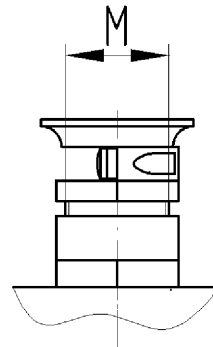

version .3

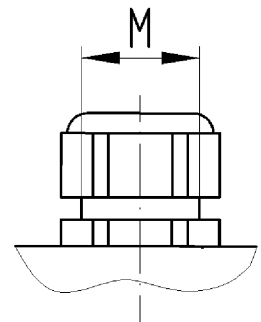

version .5

IP 65

Gehäuseoberteil
70.352.2435.0

Zeichnungsnummer
70.352.2435.010W
Gehäuseoberteil

30.11.2007
Hoffmann Angelika
M 1:2